

A

B

C

D

1

2

3

4

5

6

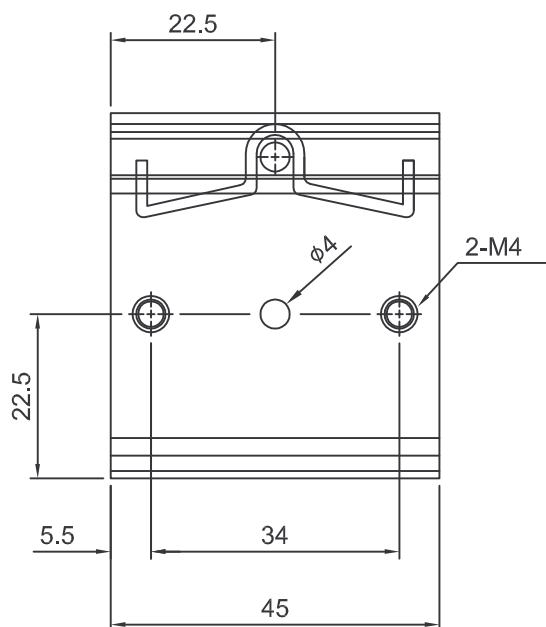
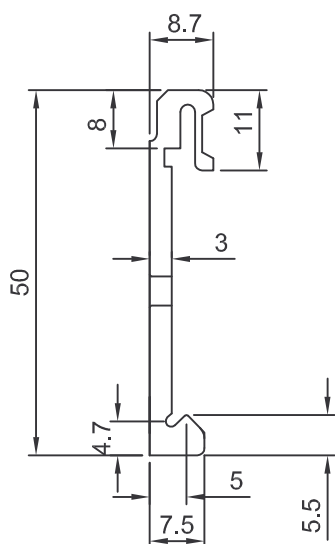

MATERIAL: Al. 6063-T5
材質: 鋁

FINISH: Degreasing Cleaning Fluid
處理: 脫脂洗清

UNIT: mm
單位

DWG NAME: Mounting Accessories
圖號: 機構配件圖

THICKNESS:
厚度

TOL.: Angle: $\pm 1^\circ$
 $6 \pm 0.1\text{mm}$ 30 to 120: $\pm 0.3\text{mm}</math>
公差 6 to 30: $\pm 0.2\text{mm}</math> 120 to 315: $\pm 0.5\text{mm}</math>$$$

ORDER NO.: DRP-03
品號

DATE: 2005-10-17
日期

REV. R2
版本